

REVOLABS Elite™ Wired Microphones

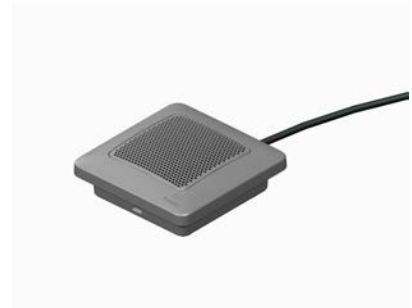

Installation and Operation Guide

Models:

01-EWM5-DR-BLK

01-EWM5-OM-BLK

01-EWM5-GN6-BLK

01-EWM5-GN12-BLK

01-EWM5-DR-WHT

01-EWM5-OM-WHT

01-EWM5-GN6-WHT

01-EWM5-GN12-WHT

01-EWM5-DR-BNI

01-EWM5-OM-BNI

01-EWM5-GN6-BNI

01-EWM5-GN12-BNI

© 2015 REVOLABS, INC. All rights reserved. No part of this document may be reproduced in any form or by any means without express written permission from Revolabs, Inc. Product specifications are subject to change without notice.

Revolabs Elite Wired Microphone Installation and Operation Guide
10-EXECWM5GUIDE-EN
June 2015 (Rev 1.0.0)

Introduction

Congratulations on your purchase of the Revolabs Elite™ Wired Microphone with Mute control and indicator light. This microphone utilizes state of the art technology providing high bandwidth audio and enabling clear, reliable audio capture for your applications.

Please read this documentation carefully and follow the instructions before installing and using your Elite™ Wired Microphone.

Safety and General Information

Please read the following information to ensure safe and efficient use of your Revolabs system.

FCC Notice to Users

This device complies with Part 15 of the FCC Rules. Operation is subject to the following two conditions: (1) this device may not cause harmful interference, and (2) this device must accept any interference received, including interference that may cause undesired operation.

Users are not permitted to make changes or modify the equipment in any way. Changes or modifications not expressly approved by Revolabs, Inc. could void your authority to operate this equipment under Federal Communications Commission's rules.

RADIO AND TELEVISION INTERFERENCE

This equipment has been tested and found to comply with the limits for a Class B digital device, pursuant to Part 15 of the FCC rules. These limits are designed to provide reasonable protection against harmful interference in a residential installation. This equipment generates, uses and can radiate radio frequency energy and, if not installed and used in accordance with the instructions, may cause harmful interference to radio communications. However, there is no guarantee that interference will not occur in a particular installation. If this equipment does cause harmful interference to radio or television reception, which can be determined by turning the equipment off and on, the user is encouraged to try to correct the interference by one or more of the following measures:

- Reorient or relocate the receiving antenna.
- Increase the separation between the equipment and the receiver.
- Connect the equipment into an outlet on a circuit different from that to which the receiver is connected.
- Consult the dealer or an experienced radio/TV technician for help.

You may also find helpful the following booklet, prepared by the FCC: "How to Identify and Resolve Radio-TV Interference Problems." This booklet is available from the U.S. Government Printing Office, Washington D.C. 20402

Industry Canada Notice to Users

Operation is subject to the following two conditions:

- (1) This device may not cause interference and
- (2) This device must accept any interference, including interference that may cause undesired operation of the device

Le présent appareil est conforme aux CNR d'Industrie Canada applicables aux appareils radio exempts de licence. L'exploitation est autorisée aux deux conditions suivantes : (1) l'appareil ne doit pas produire de brouillage, et (2) l'utilisateur de l'appareil doit accepter tout brouillage radioélectrique subi, même si le brouillage est susceptible d'en compromettre le fonctionnement.

Notice to European Customers



Revolabs, Inc.
190, High Street,
Tonbridge, Kent,
TN9 1BE,
UK.

Declare that for the hereinafter mentioned product model numbers, the presumption of conformity with the applicable essential requirements has been approved in accordance with the Electromagnetic Compatibility (EMC) Directive 2004/108/EC, and RoHS II Directive 2011/65/EU.

Model Number:	Description:
01-EWM5-DR	Elite Wired Directional Microphone with Mute Control and Indicator
01-EWM5-OM	Elite Wired Omnidirectional Microphone with Mute Control and Indicator
01-EWM5-GN6	Elite Wired Gooseneck Microphone with Mute Control and Indicator, 15 cm
01-EWM5-GN12	Elite Wired Gooseneck Microphone with Mute Control and Indicator, 30 cm

Any unauthorized modification of the products voids this Declaration.
For a copy of the original signed declaration of conformity, please contact Revolabs at the above address.

WEEE Notification

The Waste Electrical and Electronic Equipment (WEEE) directive (2012/19/EU) is intended to promote recycling of electrical and electronic equipment and their components at end of life.

According to the requirement of the WEEE legislation the following user information is provided to customers for all branded Revolabs products subject to the WEEE directive.



“The symbol on the product or its packaging indicates that this product must not be disposed of with your other household waste. Instead, it is your responsibility to dispose of your waste equipment by handing it over to a designated collection point for the recycling of waste electrical and electronic equipment. The separate collection and recycling of your waste equipment at the time of disposal will help conserve natural resources and ensure that it is recycled in a manner that protects human health and the environment. For more information about where you can drop off your waste for recycling, please contact your local authority, or where you purchased your product.”

Safety Warnings

- Follow the instructions in the Revolabs Elite Wired Microphone Installation and Operation Guide.
- Do not expose any of the Elite Wired Microphones to water, moisture, or high humidity.
- Do not expose any of the Elite Wired Microphones to extreme high or low temperatures.
- Do not expose any of the Elite Wired Microphones to lit candles, cigarettes, cigars, or to open flames, etc.
- Do not drop, throw, or try to bend the microphones, as rough treatment could damage them.
- Do not open the casings of any of the Elite Wired Microphones.
- Do not use any other accessories than Revolabs' originals intended for use with this product. Use of non-original accessories may result in loss of performance, damage to the product, fire, electric shock or injury. The warranty does not cover product failures which have been caused by use of non-original accessories.

Content

Introduction	3
Safety and General Information	4
FCC Notice to Users.....	4
Industry Canada Notice to Users	5
Notice to European Customers.....	5
WEEE Notification.....	6
Safety Warnings	6
Content	7
Components	8
Installation	9
Dip switch Settings	9
Audio wire connection	11
Control Wire Connection.....	12
Microphones	12
The Elite Omni-Directional Wired Tabletop Boundary Microphones.....	12
The Elite Directional Wired Tabletop Boundary Microphones	14
The Elite Gooseneck Tabletop Microphones	15
Warranty	15
Technical Support	16
Specifications	16

Components

Your Revolabs Elite Wired Microphone comes with a 15' (4.5 m) cable attached to connect it to a phantom powered microphone input of a digital signal processor (DSP), or other audio devices. The packaging includes the microphone with cable and a short installation documentation.

The Revolabs Elite system is designed to optimize audio capture by providing consistent and high-level audio input from all participants.

You might have purchased additional components like the installation kit to install your microphones permanently. Please review the documentation of these components for their installation information.

Installation

The Elite Wired Microphones with Mute Control and Indicator are equipped with a 15' (4.5 meter) cable that allows integration with audio equipment. If the microphone mute is controlled locally, only the audio wires (mic positive (red), mic negative (black), and ground) need to be connected to the audio equipment.

If external mute control is being implemented, and the LED indicator on the microphone is controlled externally, the switch out (green), LED in (blue) and I/O ground cables also need to be connected to the GPIO ports controlling the behavior.

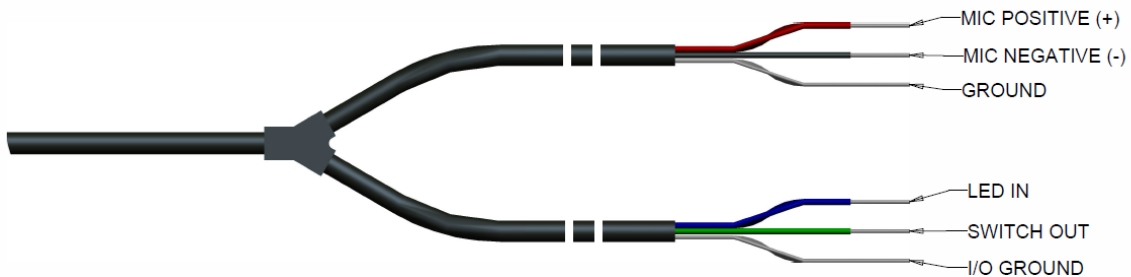

Dip switch Settings

The DIP switches manage the behavior of the mute control (mute button) and the LED indicator light on the microphone. The switches are located on the bottom of the microphone and numbered 1 through 6.

To access the DIP switches, remove the bottom door of the microphone using a screwdriver or similar tool to press on the latch and then remove the door. Set the DIP switches based on the following tables to achieve the intended behavior.

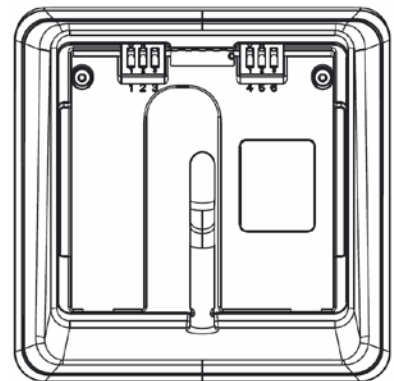
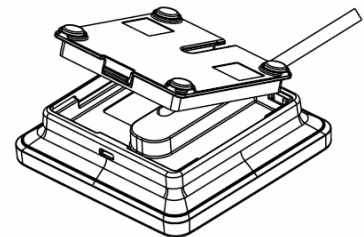

External Control

When external Control is desired, DIP switch One needs to be in the ON position.

Mode	Switch Position					
	1	2	3	4	5	6
External Control Enabled, >2.8V in = Red LED , <2.4V in = Green LED	ON	OFF	OFF	OFF	OFF	OFF
External Control Enabled, >2.8V in = Green LED , <2.4V in = Red LED	ON	ON	OFF	OFF	OFF	OFF

DIP switches 3 – 6 should be in the OFF position. If any of these DIP switch is set to ON, local control of the mute functionality will be enabled, causing unwanted and unpredictable microphone mute behavior and might lead to audio distortions.

Local Mute Control

To enable local mute control (and disable the Switch Out wire and LED In wire), DIP switch One needs to be in the OFF position.

DIP switch 2 should be in the ON position – the LED will show green when the microphone is unmuted, red when it is muted. If DIP switch 2 is in the OFF position, the LED behavior will be oposit (green when muted, red when unmuted).

Only one of the DIP switches 3 through 6 should be in the ON position, the others should be in the OFF position, depending on the mute behavior desired.

Mode	Switch Position					
	1	2	3	4	5	6
Local Control, Push to Talk	OFF	ON	ON	OFF	OFF	OFF
Local Control, Push to Mute	OFF	ON	OFF	ON	OFF	OFF
Local Control, Mute Toggle, start muted	OFF	ON	OFF	OFF	ON	OFF
Local Control, Mute Toggle, start unmuted	OFF	ON	OFF	OFF	OFF	ON
Microphone is always on (no mute functionality)	OFF	ON	OFF	OFF	OFF	OFF

If more than one of the DIP switches 3 – 6 is in the ON position, unwanted and unpredictable microphone mute behavior will be observed and audio distortions will be experienced.

In Push to Mute mode, the microphone send audio data, unless the button is pressed, at which time the microphone will mute.

In Push to Talk mode, the microphone is muted, unless the user presses the button, at which time the microphone sends audio data until the button is released again.

In Toggle mode, the microphone is muted or unmuted, changing its state each time the button is pressed.

Factory preset

Factory preset for the DIP switches is on local control, red LED light indicates mute, mute toggle starting unmuted.

Mode	Switch Position					
	1	2	3	4	5	6
Local Control, Mute Toggle, start unmuted	OFF	ON	OFF	OFF	OFF	ON

Audio wire connection

Connect the red wire to the positive (+) microphone input of the DSP or audio equipment you use with the microphone. Similarly, connect the black wire with the negative (-) input of the DSP. When connecting to a male XLR connector, use the following polarity:

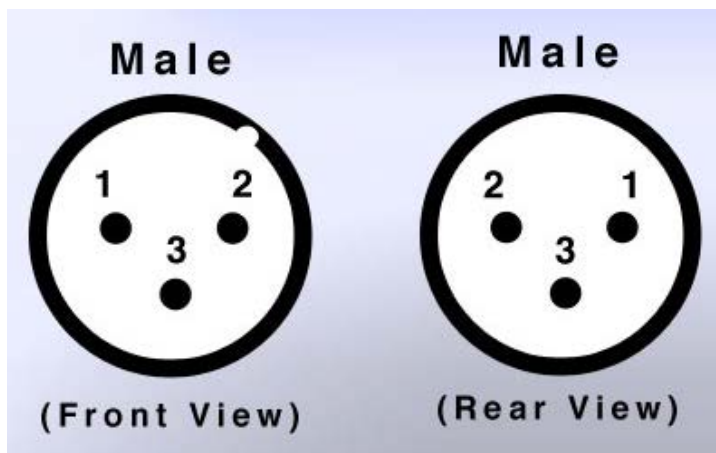

- 1 – Ground / Shield
- 2 – Positive (+)
- 3 – Negative (-)

Note: The Elite Wired Microphone includes some active electronic circuitry, and therefore requires Phantom Power to be provided from the device the microphone is connected to. The Elite Wired Microphone requires a phantom voltage between 12 and 48V DC, with a draw of maximum 2mA.

Control Wire Connection

The Control wires will be connected with the GPIO ports of the DSP or other technology that is controlling the mute status of the microphones. The control wires are only used when external control is selected using the DIP switches.

Using external control, pressing the button on the microphone will pull the switch out line to ground. The DSP (or other technology) needs to be programmed to react to falling edge (e.g. mute toggle), or for the switch out line to be “low” (e.g. push to talk).

The LED In line should be connected to a GPIO out port. The Elite wired microphones provide red and green LEDs to differentiate the state of the microphones. The LED color is controlled by the DIP switch setting and the voltage provided on this line. See the table on the DIP switch settings for more details.

Microphones

Revolabs Elite Wired Microphones come in four different versions:

- Revolabs Elite Omni-directional Tabletop Wired Boundary Microphone
- Revolabs Elite Uni-directional Tabletop Wired Boundary Microphone
- Revolabs Elite 6 in (15 cm) Gooseneck Tabletop Wired Microphone
- Revolabs Elite 12 in (30 cm) Gooseneck Tabletop Wired Microphone

The Elite Omni-Directional Wired Tabletop Boundary Microphones

The Elite Omni-directional Wired Tabletop Boundary Microphones enable multiple conference attendees to use a single microphone.

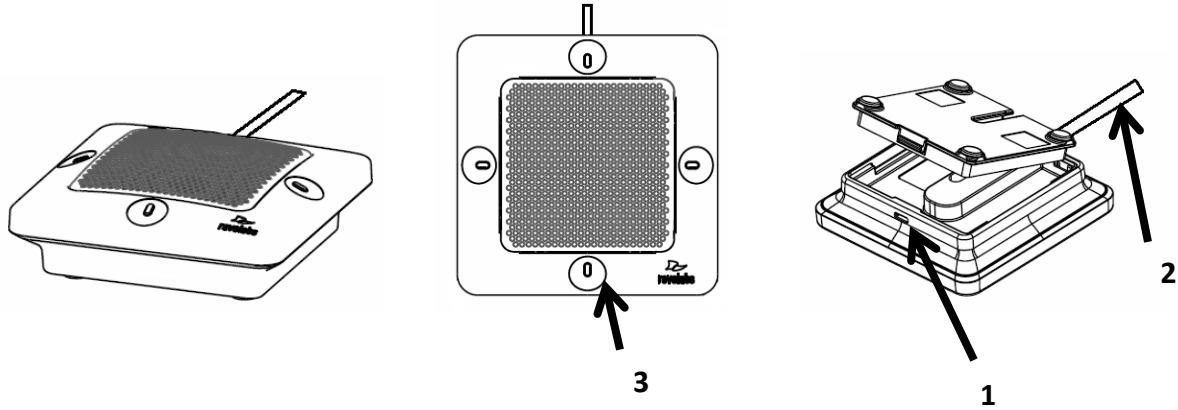

1. Bottom door latch — open the bottom to change the DIP switch settings. Or replace the bottom cover for permanent installations using this latch.
2. Audio wire — connect the microphone to the DSP or other audio equipment using this wire.
3. Button — Local mute control, or pulling the external control line to ground when pressed.

To use the Elite Omni-Directional Tabletop Microphone, it should be centered on the table within 2 to 6 feet (0.6 to 2m) from people speaking and do not need to be pointing any particular direction as they pick up sound from all directions.

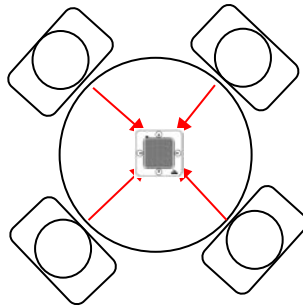

It is always better to place a microphone as close to meeting participants as possible, while avoiding placing the microphone where it might be blocked by equipment or paperwork. Do not place microphones too close to an audio or video conference speaker to avoid echoes. Make sure that the microphone's rubber feet are sitting atop a flat surface.

The Elite Directional Wired Tabletop Boundary Microphones

The Elite Directional Wired Tabletop Boundary Microphone, shown below, is designed to provide optimum coverage when placed on a conference room table in front of one to three people.

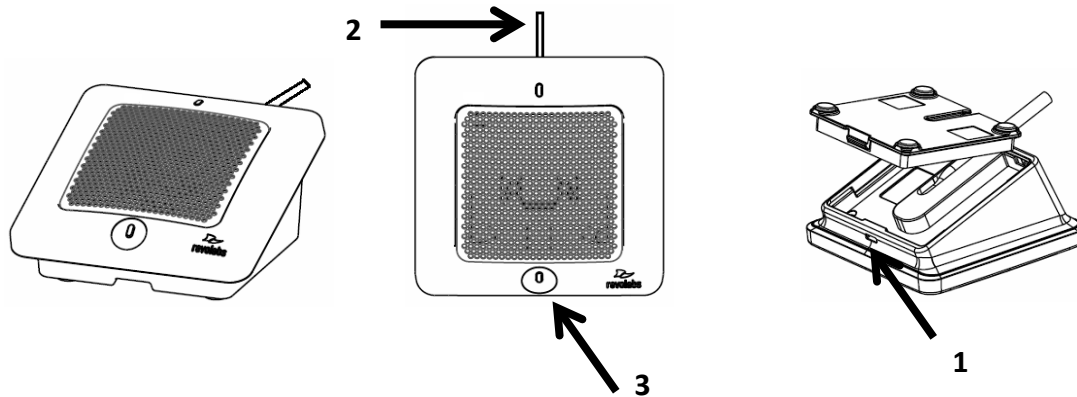

1. Bottom door latch — replace the bottom cover for permanent installations using this latch.
2. Audio wire — connect the microphone to the DSP or other audio equipment using this wire.
3. Button — Local mute control, or pulling the external control line to ground when pressed.

To use the Elite Directional Tabletop Microphone, it should be placed on the table with the metal screen facing toward the users, trying to keep the microphone 2 to 6 feet (0.6 to 2m) from the target people. The pick-up pattern for this directional microphone is approximately $\pm 65^\circ$ to either side of directly in front of the microphone.

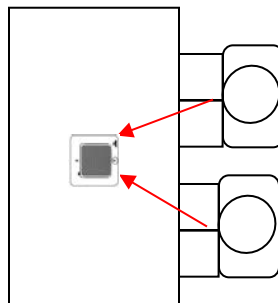

It is always better to place a microphone as close to meeting participants as possible, while avoiding placing the microphone where it might be blocked by equipment or paperwork. Do not place microphones too close to an audio or

video conference speaker to avoid echoes. Make sure that the microphone's rubber feet are sitting atop a flat surface.

The Elite Gooseneck Tabletop Microphones

The Elite Gooseneck Tabletop Microphones, 6 inch and 12 inch (15 cm and 30 cm, respectively), shown below, are designed to provide optimum coverage when placed on a conference room table in front of one person.

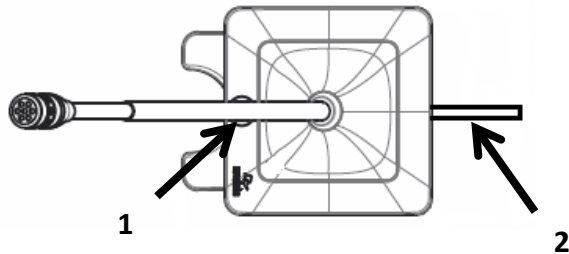

1. Button – Local mute control, or pulling the external control line to ground when pressed.
2. Audio wire — connect the microphone to the DSP or other audio equipment using this wire.

To use either of the Elite Gooseneck Tabletop Microphones it should be located on the table with the microphone pointing toward the user, trying to keep the microphone 18 to 24 inches (45 to 60 cm) from the speaker. The pick-up pattern for this directional microphone is cardioid, focusing a “beam” towards the speaker.

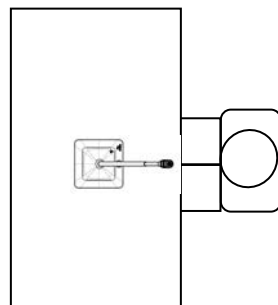

It is always better for the microphone to be as close to the person speaking as possible, but avoid placing the microphone where it might be blocked by equipment or paperwork. Avoid placing microphones too close to an audio or video conference speaker to avoid echoes. Make sure that the microphone is always placed standing on its rubber feet atop a flat surface.

Warranty

Revolabs, Inc. warrants this product to be free of manufacturing defects. Repair or replacement of any defective part or unit (at the discretion of the

Seller) will be free of charge for the period defined in the Revolabs Professional Products Limited Warranty.

Any attempt by the user to alter the equipment, or equipment damaged by negligence, accident, or Acts of God voids this warranty.

The Seller shall not be liable for any consequential damage resulting from the malfunction of this product. Should the user experience unsatisfactory performance from this equipment, contact the Seller to obtain instructions for return, or replacement, as deemed necessary.

This warranty is not transferable by the original end user. Complete details and terms of the Limited Warranty can be found at www.Revolabs.com.

Revolabs, Inc.
144 North Road SUITE3250
Sudbury, MA 01776
www.revolabs.com
800.326.1088

Technical Support

If you are experiencing technical problems or if you have questions about the operation, configuration or troubleshooting of any Revolabs product, please email support@revolabs.com or call 1-800-326-1088.

Specifications

Product Dimensions

Microphone	Dimensions	Weight
Omni-Directional Tabletop	3.125 x 3.125 x 1.125 in 7.9 x 7.9 x 2.9 cm	6.6 oz. 188 g
Directional Tabletop	3.125 x 3.125 x 1.75 in 7.9 x 7.9 x 4.4 cm	7.2 oz. 205 g

Audio Specifications

Omni-Directional Tabletop		
	Frequency Response	160Hz – 16,000 Hz
	SNR	70 dB
	Max SPL @1kHz, 1% THD	108dBSPL
	Dynamic Range	83 dB
	Sensitivity @1kHz	-34.8dBV

	Local mute attenuation	100dB minimum
--	------------------------	---------------

Directional Tabletop		
	Frequency Response	160Hz – 16,000 Hz
	SNR	68 dB
	Max SPL @1kHz, 1% THD	113 dBSPL
	Dynamic Range	87 dB
	Sensitivity @1kHz	-36.2dBV
	Local mute attenuation	100dB minimum

Goseneck Microphones		
	Frequency Response	160Hz – 16,000 Hz
	SNR	68 dB
	Max SPL @1kHz, 1% THD	113 dBSPL
	Dynamic Range	87 dB
	Sensitivity @1kHz	-36.2dBV
	Local mute attenuation	100dB minimum

Microphone Polar Patterns

Elite Omni-Directional Wired Tabletop Microphone :

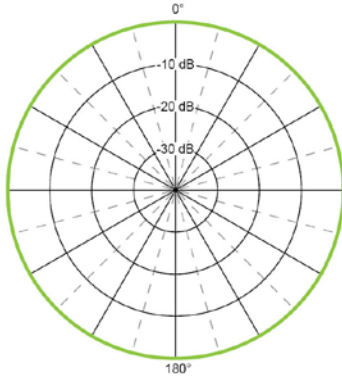

Elite Directional Wired Tabletop Microphone:

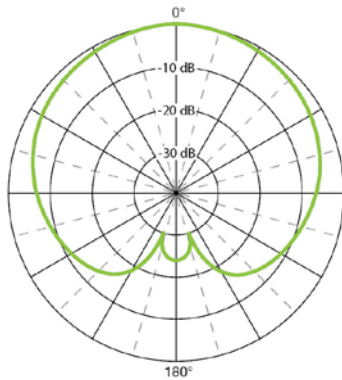

Elite Gooseneck 6 or 12 inch (15 cm or 30 cm, respectively) Tabletop Microphone:

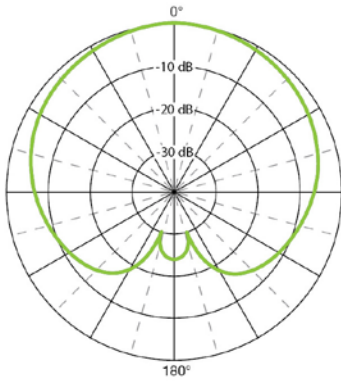

Revolabs Eilte Wired Microphone Installation and Operation Guide
10-EXECWM5GUIDE-EN
June 2015 (Rev 1.0.0)